

User Manual

CT101 line stage / linear preamplifier module

CT101 2-channel line stage / preamplifier module

CONTENT

- Unpacking**
- Connections**
 - Definitions
 - Power supply
 - Signal input
 - Signal output
 - Volume control
 - Gain setting
- Power supply**
- Volume control**
- Gain setting**
- Mounting / assembling**
- Other information**
 - Headphones
 - Balanced preamplifier
 - 6-channel A/V audio
 - DC offset
 - Hints
- Caution**



Please make sure to read through all of this Manual before connecting your CT101.

Side view

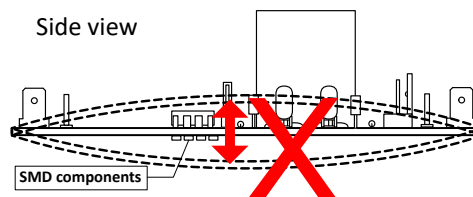

Do not bend the CT101 PCB.
Bending it may easily damage the SMD components on the rear side.

UNPACKING

Thank you for purchasing this Danish Audio Connect product. CT101 is a ready-made 2-channel linear audio preamplifier module built on a compact PCB. CT101 is specifically designed for using with a DACT stepped audio attenuator as volume control. Connecting CT101 to input/output sockets and an external power supply will provide you with a high quality, no-nonsense, active preamplifier. Your CT101 purchase includes

- 1 pc. CT101 2-channel linear preamplifier module
- 2 pcs. power supply connectors including wires
- 3 pcs. jumpers for using CT101 with one power supply

We recommend that you make sure to keep all of the above items after unpacking your CT101, as everything will prove useful when mounting and connecting your CT101.

CONNECTIONS

Definitions

'Marking' refers to the text printed on the CT101 Printed Circuit Board:

<u>Marking</u>	<u>Definition</u>
IN 1	Signal input, channel 1
IN 2	Signal input, channel 2
OUT 1	Signal output, channel 1
OUT 2	Signal output, channel 2
P1, 1 2 3	Attenuator, channel 1
P2, 1 2 3	Attenuator, channel 2
+/-	Power supply to one or both of the 3-way connectors

Please also refer to Fig. 1 below.

CT101 2-channel line stage / preamplifier module

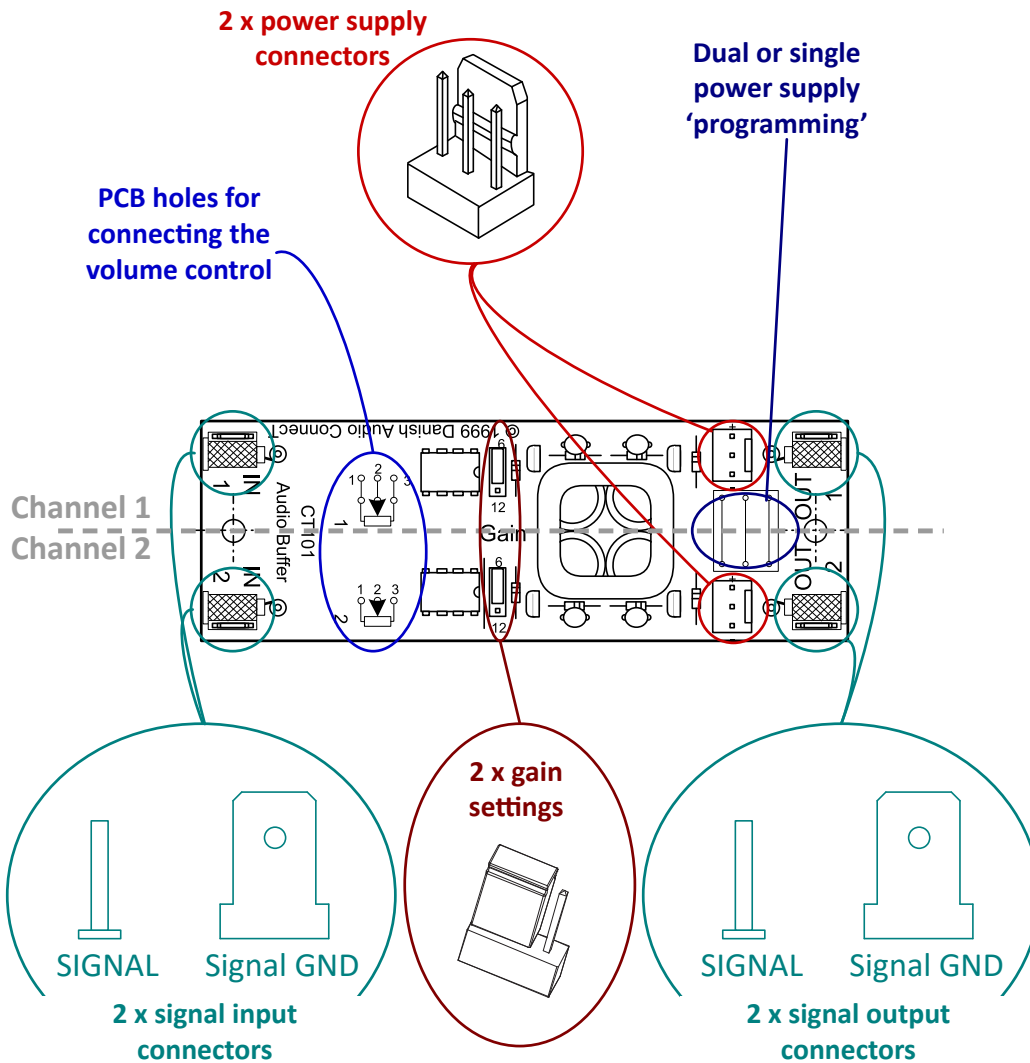

Fig. 1. CT101 connections

Power supply

CT101 is designed for using with either one +/- power supply common for both channels, or with a +/- power supply for each channel. The two channels of CT101 are completely separated on the PC Board. Therefore, when a power supply for each channel is used, the operation is true dual-mono.

The power supplies must be connected to the 3-way square pin headers as shown in fig. 1 and fig. 2 (exact connector dimensions specified in the CT101 Datasheet).

The colour codes (RED, BLACK, BLUE) in fig. 2 refer to the colours of the wires attached to the two separate power supply connectors, which are included when purchasing a CT101.

For more details please refer to the POWER SUPPLY chapter on the following pages.

Signal input

The input terminals are marked IN 1 and IN 2 on the CT101 PCB, and consists each of a round pin terminal and a flat tab terminal (specified in the CT101 Datasheet).

Generally, we recommend connecting the inputs with screened cables. The longer the input cables are, the more important is the screening. If the distance between the input sockets and the CT101 PCB is short, non-screened cables may be used. For non-screened signal cables, we recommend twisting the signal and the signal ground wires. For each channel, the cable outer conductor (screen - braid/foil) must be soldered to the flat tab connector (~'spade terminal'), and the cable centre conductor (core) must be soldered to the round pin terminal. See fig. 3 below.

CT101 2-channel line stage / preamplifier module

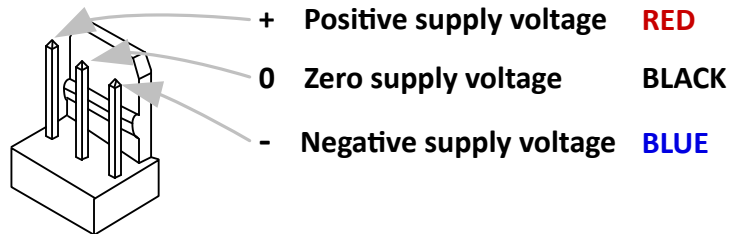

Fig. 2. CT101 power supply connections

Signal output

The output terminals are marked OUT 1 and OUT 2 on the CT101 PCB, and consist each of a round pin terminal and a flat tab terminal (specified in fig. 3 of the CT101 Datasheet).

Generally, we recommend connecting the outputs with screened cables. The longer the output cables are, the more important is the screening. If the distance between the output sockets and the CT101 PCB is short, non-screened cables may be used. For non-screened signal cables, we recommend twisting the signal and the signal ground wires. For each channel, the cable outer conductor (screen - braid/foil) must be soldered to the flat tab connector (~spade terminal), and the cable centre conductor (core) must be soldered to the round pin terminal. See fig. 3.

Volume control

The CT101 PCB features holes and connections for a volume control for each of the two channels, marked P1 and P2. See fig. 1. The layout is made, so a DACT stereo CT2 stepped attenuator will fit directly. For more details please refer to the VOLUME CONTROL chapter on the following pages.

Gain setting

The gain of CT101 can easily be set at either 0dB ('buffer-mode'), 6dB or 12dB. Please see fig. 1. For more details please refer to the GAIN SETTING chapter on the following pages.

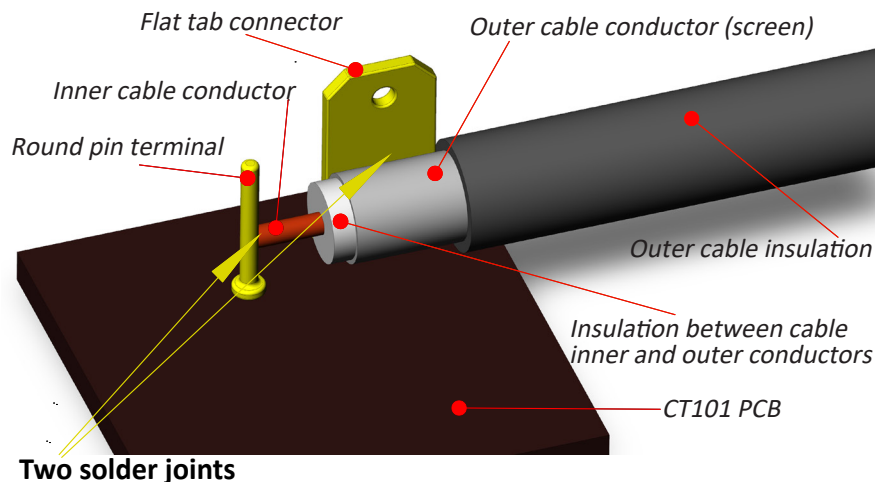

Fig. 3. CT101 audio signal input/output connections

CT101 2-channel line stage / preamplifier module

POWER SUPPLY

Requirements

CT101 is delivered without power supply in order to let the user decide for and experiment with his own power supply design. For information about available power supplies from DACT, please visit <http://www.DACT.com>.

CT101 requires a +/- DC power supply to operate. Maximum supply voltages and recommended supply voltage are specified in the CT101 Datasheet.

For typical applications, where CT101 is used to drive loads of 5kOhm or greater, the recommend supply voltage is between +/-17VDC and +/-35VDC.

If CT101 is used to drive loads with lower impedance (for instance headphones), it is advised to limit the supply voltage to between +/-17VDC and +/-24VDC. Otherwise, the output devices of CT101 may become overheated.

Under typical use, driving a load of 5kOhm or more, CT101 draws less than 3mA per channel. Driving lower impedances will increase the supply current.

Please be very careful about connecting the power supply correctly.

Connecting the power supply

An easy and convenient way to connect the power supply is to use one or both of the 3-way connectors, which are included when purchasing a CT101, see fig. 4. Each of them has three wires attached, and they fit the two 3-way pin connectors on the CT101 PCB (shown in fig. 2). Positive and negative supply connections are printed on the PCB as + and -. The red wire must be connected to the positive supply voltage, the blue wire to the negative supply voltage, and the black wire to zero supply voltage. Make sure to connect the power supply polarity correctly.

Wrong polarity may destroy CT101 and connected equipment. See also the CAUTION paragraph on the last page.

Using an existing power supply

One possibility of powering CT101 is from existing audio equipment, like power amplifiers, CD-players, etc. This is often possible because CT101 requires only little supply current, and because it accepts a wide supply voltage range. Especially when building CT101 into existing equipment, this way of powering it is an option.

Before experimenting with ready-made audio equipment, please observe that the warranty of the equipment will usually no longer be valid. We recommend that only trained technicians make this kind of 'surgery'.

Audio power supply

Although CT101 has two voltage regulators for each channel built-in, it is recommend paying attention to the quality of the external power supply. In spite of the built-in voltage regulators, the quality of the external power supply has significant influence on the sound quality of CT101. In our view, a good audio supply for instance features:

- ability to deliver current pulses with high speed
- low output resistance far beyond the audio frequency range
- low noise
- high ripple suppression

The DACT CT102 Audio Power Supply was designed for purposes like powering CT101.

Due to the low power consumption of CT101, battery operation is a possibility. Sound testing of CT101 operated by batteries was included in the design phase, and the results proved excellent. Either rechargeable or nonrechargeable batteries may be used.

For most types of power supplies, including batteries, we recommend adding some high quality reservoir electrolytic capacitors. It is important that the reservoir capacitors have low ESR, also at high frequencies. Some electrolytic capacitors are specially optimized for higher frequencies, and have ESR specified at 100kHz. We recommend using these types, for instance with capacitance values of 2,200uF each. The reservoir capacitors should be mounted on the supply lines, as close to CT101 as possible, so only short wires are required. A simplified schematic is shown in fig. 5.

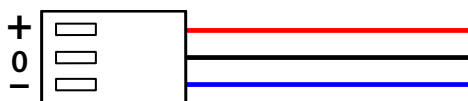

Fig. 4. Power supply cables included with CT101

CT101 2-channel line stage / preamplifier module

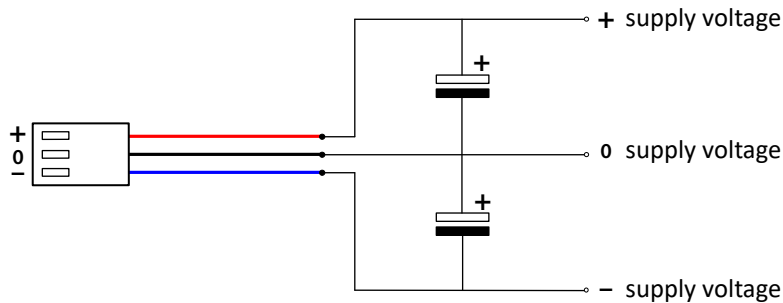

Fig. 5. Connecting low impedance power supply reservoir capacitors to CT101

Dual mono (dual power supply)

For optimal performance (especially benefiting channel separation), we recommend using a separate power supply for each CT101 channel (dual mono). Both power supplies should be identical and meet the above-mentioned requirements.

When purchasing a CT101, the package includes 3 pcs jumpers. In case a +/- power supply is used for each channel, the three jumpers are not used. In case one power supply is used common for both channels, the three jumpers must be mounted on the front side, and soldered in both ends to the backside of the CT101 PCB. See fig. 6. If a common power supply is used, it may be connected to the 3-way connector of either channel 1 or channel 2.



WARNING!

If the CT101 is power supplied incorrectly with only a positive or only a negative supply-half connected, a DC voltage of several Volts may occur on the output terminals OUT 1 and OUT 2. See also the CAUTION chapter on the last page of this manual.

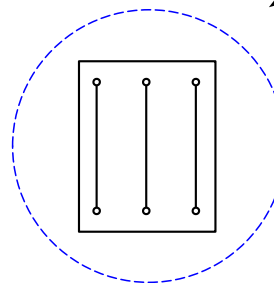
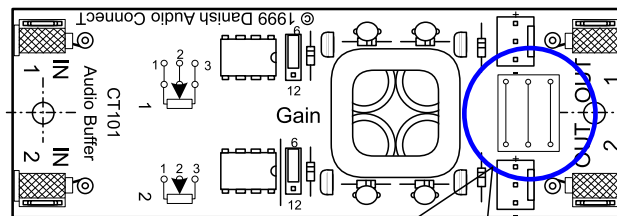

Using one power supply for each channel:
The jumpers are not mounted

or

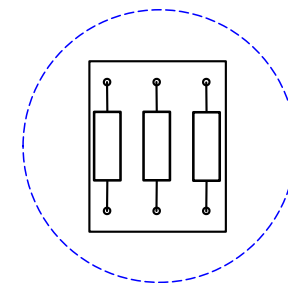

Using one common power supply for both channels:
The jumpers are mounted

Fig. 6. CT101 jumpers for using one or two +/- power supplies

VOLUME CONTROL

Principally CT101 can be used with any volume control. However, we recommend using a high-grade control. Only the best volume controls will not influence the sound quality of CT101. Especially, we recommend using a DACT stepped audio attenuator with CT101. The CT101 PCB layout makes it possible to fit a DACT CT2 stereo attenuator just by soldering 6 connections on the backside of the PCB.

The best way is to solder the volume control directly into the CT101 PCB, obtaining the shortest possible signal path and the best sound. If this is not possible, DACT offers a connection kit (CT-conn1) that does not require soldering on the attenuator. The connection kit includes 3 x 30cm (3 x 12") wires. For longer distances, using shielded wires is recommended.

CT101 2-channel line stage / preamplifier module

Instead of mounting the volume control apart from CT101, a better solution is to fit both together inside the enclosure, and extend the volume control's shaft.

Make sure always to attach the volume control to the equipment enclosure, to a bracket, or similar. The volume control **SHOULD NOT** be fastened only by soldering it to the CT101 PCB.

Volume controls are available with many different resistances. DACT offers stepped attenuators in 10, 20, 50, 100, 250 and 500kOhm. It is our experience that the lower resistance volume controls sound better than high resistance volume controls when used with CT101. Therefore, we normally recommend using a 10kOhm attenuator with CT101.

There is one more concern when deciding which attenuator resistance to use for CT101: The attenuator is connected directly across the audio signal input. Therefore, the attenuator resistance determines the input resistance of the complete unit. So for instance a 10kOhm attenuator will fix the CT101 input resistance at 10kOhm.

When using a DACT attenuator with CT101, the attenuator must be soldered to the CT101 PCB in the right way. Looking at CT101 with the audio input connectors pointing to the left, and with the component side upwards, the DACT attenuator must be mounted so the attenuator shaft points towards you. See also fig. 10.

If a metal enclosure is used, usually the attenuator will be fastened directly to a part of the enclosure, so the attenuator click-house is connected to chassis ground (fig. 10). In case the attenuator metal housing is not connected to chassis ground when mounted, there should be made a separate ground connection so the attenuator metal parts are securely grounded. See also the <http://www.DACT.com> attenuator pages.

In certain cases, it is not required to use a volume control with CT101. If there is no volume control connected to CT101, a jumper must be mounted in each CT101 channel, see fig. 7. In this way, the input resistance is 100Mohm. However, usually a 100Mohm input resistance is not recommendable for audio applications. Therefore, two resistors may be added to reduce the input resistance. See fig. 8. For instance, two high quality 10kOhm resistors may be added (one per channel) to set the input resistance at 10kOhm.

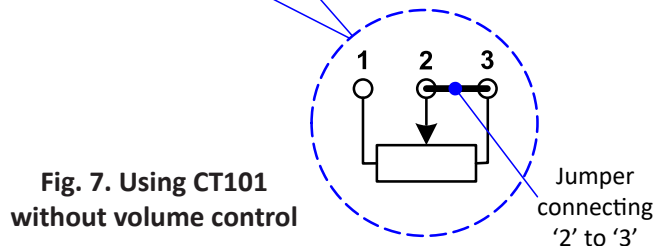
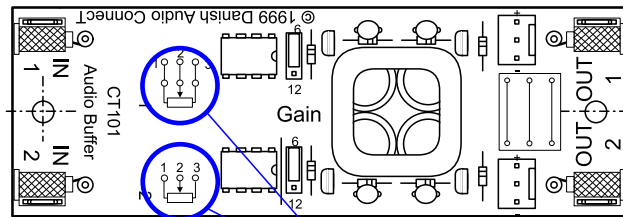

Fig. 7. Using CT101 without volume control

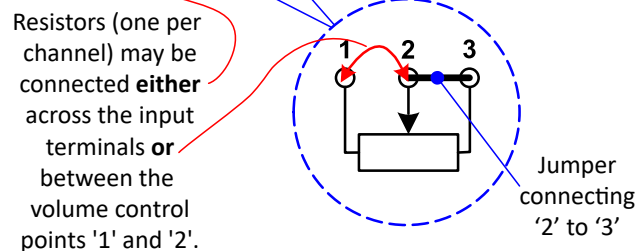
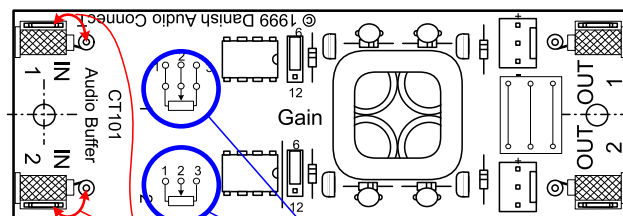

Fig. 8. Using CT101 without volume control but with resistors controlling the input resistance

GAIN SETTINGS

CT101 offers gain settings of 0dB, 6dB or 12dB. 0dB gain setting is referred to as 'buffer mode'.

The gain is set individually for the two channels, but usually the gain is set at the same level.

Gain setting is made without soldering or using any tools. The gain setting jumpers may be removed or repositioned by hand. Just remove it by pulling it away from the PCB. See fig. 9 for guidance.

It is recommended to choose the lowest usable gain setting, as the CT101 specifications at lower gain are slightly superior to specifications at the higher gain settings.

CT101 2-channel line stage / preamplifier module

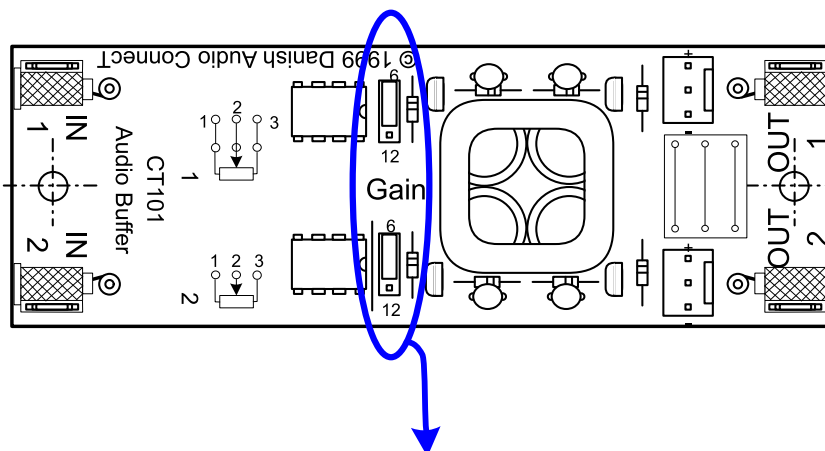
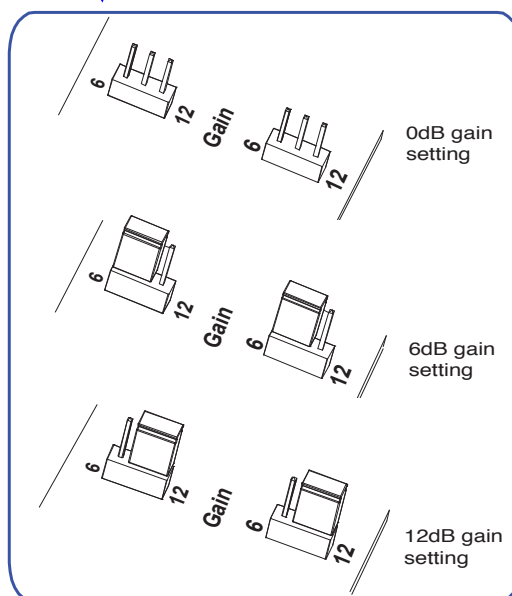

Fig. 9. CT101 gain settings



MOUNTING / ASSEMBLING

Mounting hardware

To protect CT101 against dust and larger particles, it should always be built into an enclosure. The easiest way to mount CT101 is by using the two holes in the PCB.

When mounting CT101, make sure to keep the PCB traces and solder joints on the back side at a safe distance from electrically conducting materials, in order to avoid short-circuiting.

Building CT101 into existing equipment

One possibility is to build CT101 into the enclosure of existing audio equipment, like preamplifiers, CD-players, etc. This is often possible because CT101 requires only little space, and could possibly be supplied from the existing power supply in the 'host' equipment.

Before experimenting with ready-made audio equipment, please observe that the warranty of the equipment will usually no longer be valid. We recommend that only trained technicians make this kind of 'surgery'.



CT101 2-channel line stage / preamplifier module

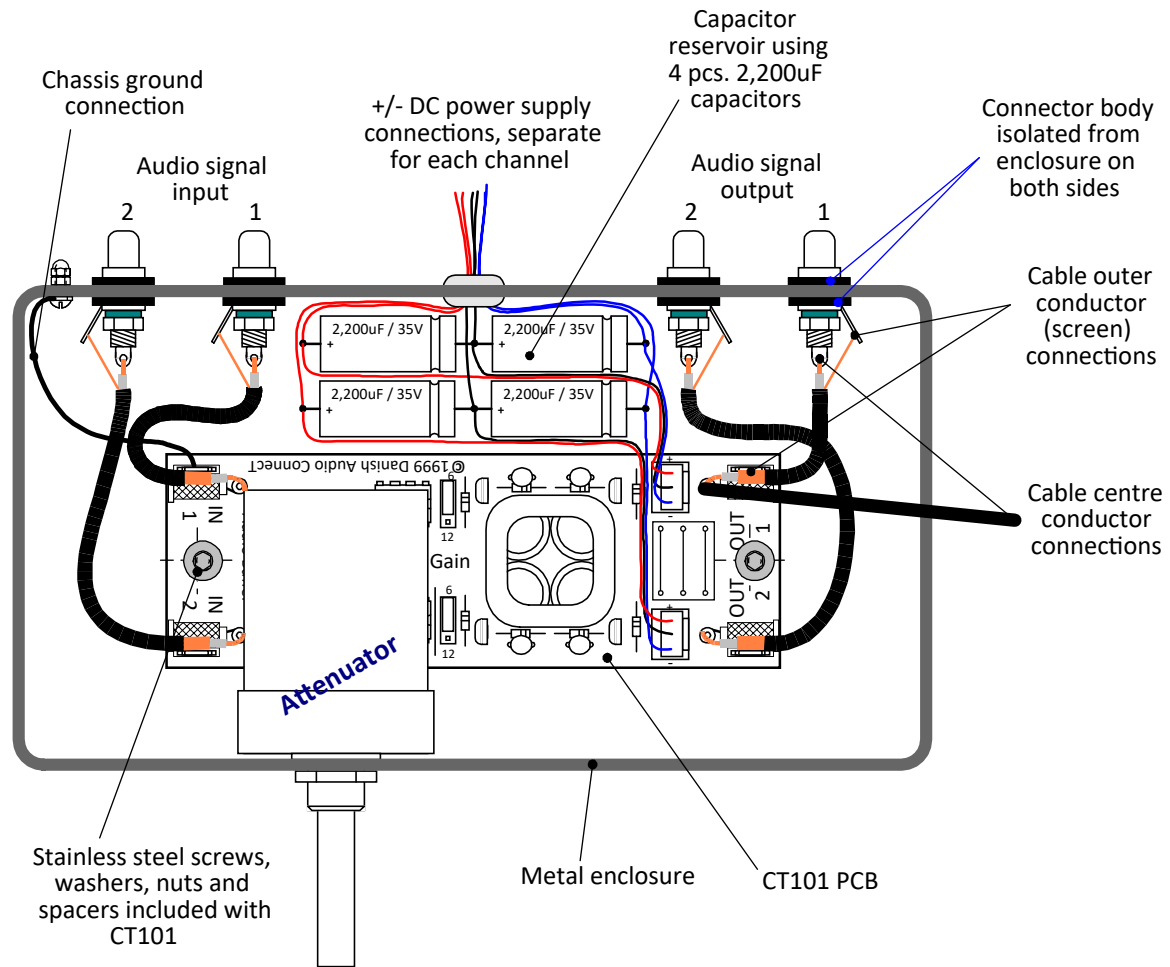

Fig. 10. CT101-based preamplifier in metal enclosure

Materials considerations

DACT believes that magnetic materials and certain plastic materials should not be used for any parts of audio electronics equipment. Magnetic materials are associated with hysteresis losses when exposed to varying electrical/magnetic fields. Plastics are associated with dielectric losses when exposed to varying electrical fields, although some plastics do have very low losses. Both phenomena introduce non-linear distortion, which disturbs low-distortion high-end audio equipment. Sometimes plastic enclosures are preferred because of their electrical non-conducting properties. In that case, we recommend using a plastic type with low dielectric loss, like for instance Teflon®, polystyrene and polypropylene. Otherwise, we recommend using an enclosure made of a non-magnetic metal. Easily and cheaply available are enclosures made of aluminium, but also copper and brass are suited materials. Metal enclosures are usually grounded and they reduce electrical fields radiated into the audio electronics, thereby reducing audible noise.

Mounting CT101 in a metal enclosure

A very typical way to mount CT101 is in a separate metal enclosure. As an example see fig. 10. For non-balanced audio equipment it is very common to use RCA sockets for audio signal input/output. To avoid hum, make sure that the body (signal GND) of the RCA sockets do not make electrical contact with the metal enclosure. Instead, as shown, make a GND connection from one of the audio input signal grounds to the chassis.

CT101 2-channel line stage / preamplifier module

OTHER INFORMATION

Headphones

Headphones may be connected directly to the output sockets of CT101, at OUT 1 and OUT 2. As headphones usually have lower impedance than 5kOhm, the supply voltage for CT101 should be limited to no more than +/- 24VDC. See also the POWER SUPPLY chapter in this manual.

The best results may be obtained using headphones with at least 600ohm resistance. Make sure to connect the phases correctly.

Balanced preamplifier

CT101 may be used for balanced audio signals. If so, one balanced audio channel requires both channels of a CT101. The positive (non-inverted) signal is connected to one channel and the negative (inverted) signal is connected to the other channel. If a balanced stereo preamplifier is required, two CT101s have to be used, one for each channel. As volume control, we recommend using a 4-deck DACT stepped attenuator. If the two CT101s are mounted next to each other, the 4-deck attenuator will fit directly into both PCBs. For more information we recommend reading the application note on using CT101 to build a multi-channel active preamplifier.

6-channel A/V audio

CT101 may be used for 6-channel A/V audio signals. Then three CT101s have to be used, for instance one for the front channels, one for the rear channels and one for the center and the sub channels. As volume control, we recommend using a 6-deck DACT stepped attenuator. If the three CT101s are mounted behind each other, the 6-deck attenuator will fit directly into all three PCBs. For more information we recommend reading the application note on using CT101 to build a multi-channel active preamplifier.

DC offset

All DC-coupled equipment always has a small DC offset at the output. CT101 typically has a DC offset around 1mV at 0dB gain setting. This level is usually not a problem. If a DC-coupled amplifier follows CT101, it must be evaluated if the DC offset level at all points in the chain of audio equipment is at acceptable levels. Especially the DC level across the loudspeaker terminals is critical. To remove the DC offsets, audio grade coupling capacitors may be added.

Hints

1. Power 'on'/'off' must be switched with a double-pole switch to ensure that both the positive and the negative supply voltage are switched simultaneously.
2. DC-coupled power amplifiers represent a potential risk for loudspeakers. Be careful to check DC levels before connecting the speakers.
3. Do not flex the CT101 PCB. This may damage the SMD components by cracking and/or breaking their solder joints.
4. When turning CT101 on for the very first time make sure to connect its outputs to an amplifier that has a volume control itself. Turn the volume fully down, then connect and turn on CT101. Gradually turn up the other amplifiers volume in order to prevent wrong wiring etc. from damaging your other audio equipment.
5. Maintenance. CT101 does not require any maintenance.
6. Modifications. We do not recommend modifying your CT101 as it is already optimized.
7. Service. If service is required, contact your dealer and arrange for further action.



Please be very cautious when connecting the CT101 to your audio equipment. CT101 is an active module, and in case of wrong connections or in case of failures, there is a risk of getting up to 14-15V DC offset on the output of CT101. High levels of DC offset may cause damages to power amplifiers, loudspeakers, or any other connected equipment. Special attention is required when using DC coupled power amplifiers. Before connecting the outputs of CT101, make sure of proper operation, and check the DC-voltage at the CT101 outputs. The DC voltage should be no more than a few mVs. In case of any doubt, start out using a coupling capacitor in series with the CT101 output.

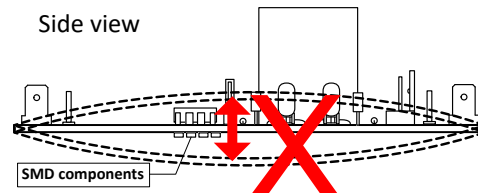

Do not bend the CT101 PCB.
Bending it may easily damage the SMD components on the rear side.

Latest update: August 12, 2024